

Textile Lifting Slings

Yale webbing slings and round slings are produced from high-tensile quality polyester (PES) in accordance with EN 1492, parts 1 and 2. The highly flexible and versatile material exerts evenly distributed pressure on pressure-sensitive and tension-sensitive loads; it is not subject to material ageing or brittleness and is heat-resistant up to +100 °C.

Lashing Systems

Yale lashing belts are produced from polyester (PES) according to EN 12195-2. The extremely resilient belt material is resistant to stretching and abrasion; it guarantees a high load bearing capacity and a long service life. All Yale lashing belts are stretched belts, thermally fixed and protected against abrasion.

INFO

Please note our user instructions at the beginning of each chapter.

Table of contents

	Page
Round slings	232 - 235
Round sling assembly	235 - 237
Webbing slings	238 - 241
Textile lifting slings accessories	242 - 245

	Page
Textile lashings	250 - 257
Special textile lashings	258 - 259
Lashing systems accessories	260 - 263

Yale

TEXTILE LIFTING SLINGS



OFFER

This user information presents a general overview regarding the application of textile lifting slings and does not substitute the existing operating instructions for specific products!

Lifting operations with textile slings may be carried out by competent users (trained in theory and practice) only.

When operated correctly, our textile slings offer the highest degree of safety in line with long life expectancy and avoid damage to products and people.

Limitations of use

Loading

Textile lifting slings must not be overloaded. The capacities for the most important lifting/sliding methods are indicated on the identity label. Always observe the maximum angle from the vertical (angle β)!

Temperature

Textile lifting slings made from polyester are admitted for applications at temperatures between $-40\text{ }^{\circ}\text{C}$ and $+100\text{ }^{\circ}\text{C}$. This temperature area may change in chemical environments. The woven structure of the drenched textiles at temperatures below $0\text{ }^{\circ}\text{C}$ are susceptible to damage due to the formation of ice.

Ice will reduce the flexibility of the lifting sling! At temperatures below $0\text{ }^{\circ}\text{C}$, dry lifting equipment should be used only! In dry condition, polyester features a high electrical resistance and provides an insulating effect between load and crane hook (e.g. during welding jobs – observe temperatures!).

Shock loading

Textile lifting and lashing equipment should not be subjected to sharp jerks and jolts in order to avoid heavy forces which may be considerably higher than the actual load weight!

Chemicals

Particular caution is required when using textile lifting equipment in areas where chemicals are present. Polyester has good resistance against mineral acids but will be destroyed by alkaline – consult our experts for advice in your specific application!

Acid may cause material brittleness to steel fittings of textile lifting slings! Harmless acid solutions may concentrate by evaporation to an extent that they provoke damages. Affected textile lifting equipment must be thoroughly rinsed in cold water, dried in open air and inspected by a competent person.

Transport of people

Transport of people with textile lifting equipment is generally forbidden!

Operation in danger zones

Lifting or transport of loads must be avoided while personnel are in the danger zone.

People are not allowed to pass over or under a suspended load!

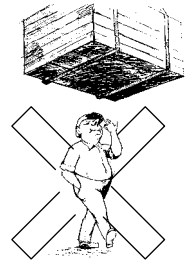

Application advices

- The operator may start moving the load only after it has been correctly attached and all personnel are clear of the danger zone.
- Loads must not be left unattended in raised or tensioned condition for a longer period of time.
- Flat webbing or round slings must not be used in knotted, tied or twisted condition and may only be used for the attachment of loads.
- Prior to every use, textile lifting and lashing equipment must be examined with regard to obvious defects. Ensure that their identity and dimensions are correct and that they are provided with a legible capacity label. Never use lifting equipment which is defective or not labelled!
- Damage of the capacity label can be avoided by keeping it away from the load, the hook or choke hitch operations!

- The angle of the eye must not exceed 20° in order to avoid inadmissible strain on the seams! This will be ensured when the eye length is approx. 4 times the width of the hook.

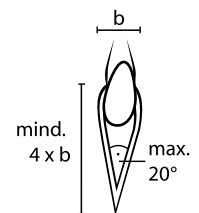

- Hooks or other lifting devices in loaded condition must not be attached in the area of sewn overlaps or at the seam of the round sling sleeve. Make sure that the seams are positioned in the straight part of the lifting device!

- Hooks should be provided with sufficient radius. The contact area of the web sling must be straight, so that the entire cross section of the sling is loaded equally. If the carrying width of flat webbing sling is below 75 mm, the radius curve of the lifting device must be at least $\frac{3}{4}$ of the width of the webbing sling.

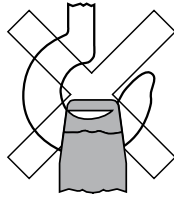

- Take care that round slings do not overlap in the crane hook. They must have sufficient space in the hook mouth as well as at the load, so they can assume their natural, flattened profile and provide even loading over the full width of the round sling.
- Flat webbing slings should be applied in such a way that they can carry the load over the full sling width. Greater angles from the vertical will strain the edges of the slings and possibly lead to breakage!
- Textile lashing equipment must be protected against sharp edges, friction and abrasion at both load and lifting device. A radius edge is classed as sharp, if it is less than the thickness of the flat webbing or round sling (in flat, loaded condition).
- Never push or place the load onto the lifting device! Never pull the load over rough surfaces or edges and do not drag from underneath a load!
- In "choke hitch" the textile sling should be positioned so that it can form a natural angle of 60° and that heat due to friction is avoided. Never re-adjust the choke hitch and prevent heat development by friction (slipping of load). In order to lift loads with plain or slippery surface we recommend double choke hitch.

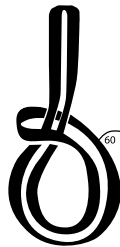

- Round slings and flat webbing slings will stretch under load by approx. 3-5%. This has to be strictly considered as it may cause abrasion resp. damages at sensible surfaces. As prevention we recommend the use of protective sleeves and edge protectors. In case of (intended) load movements during lifting operations and resulting friction, e.g. during assembling or turning of goods, the surface or edges of the load must be secured by protective sleeves or corner protectors, which will safeguard the lashing device and leave sufficient space for movement and alignment without greater friction (see dim. B in the following drawing).

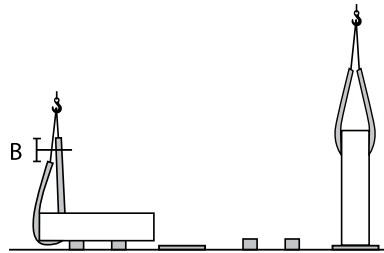

- If more than one sling is used to lift a load, these should be of same type with preferably same length in order to avoid different elongation behaviour and allow carrying ability over the full width (employ smallest angle from the vertical or use spreader beam instead).
- Textile lifting equipment must be stored in a clean, dry and well ventilated area. Avoid exposure to direct sunlight and other sources of UV. Keep them away from other heat sources, chemicals, fumes and corroded surfaces as they will have a negative effect on the life expectancy of the sling. Slings should not be dried near open fires or other hot places.
- Textile slings with obvious damages, overloading or other detrimental influences must be taken out of use and may be returned to service after inspection and possible repair only.



Maintenance and repair

Inspections and tests must be performed by competent persons or specialist workshops only.

Inspections

Depending on application, textile lifting equipment must be subjected to regular inspections by competent persons, at least once per year. The inspection must be visual and extended to the following deficiencies:

- Complete and legible identity label.
- Damages by chemical influence, e.g. local soaking, chipping of yarns or heat (hardening).
- Steel links must not show deformations, grooves or reduction to the cross section of more than 10%. Check for cracks; possible welding points must be visible and not covered by the webbing.
- Inspections have to be recorded.
- Defective slings have to be taken out of service immediately and must be stored separately!

Criteria for disposal

Textile slings must not be used any longer if e.g.:

- The marking (identity label) is missing or illegible.
- Detrimental impacts have occurred, e.g. overloading, shock loading, chemical influence or heat.

Flat webbing slings:

- Damages of selvedge, defects of the woven structure by abrasion, cuts or yarn breakages have occurred. If 10% or more of the webbing sling cross section is damaged the sling must be discarded.
- Heavy deformation or melting of yarns due to heat (shiny surface and/or hardened webbing) can be recognized.
- Load bearing seams are defective.

Round slings:

- The outside (sleeve) is damaged by cuts or abrasion.
- The inside (polyester yarns) of the sling is visible.
- The seams of the sleeve are damaged.

INFO

Yale hoists and trolleys are not designed for passenger elevation applications and must not be used for this purpose.

Webbing slings Rated capacities for different slinging methods

Factor		WLL (kg) with one webbing sling					WLL (kg) with two webbing slings			
		straight pull	choke hitch	basket angle β			straight angle β		choke hitch angle β	
				up to 7°	7°-45°	45°-60°	7°-45°	45°-60°	7°-45°	45°-60°
		1.0	0.8	2.0	1.4	1.0	1.4	1.0	1.12	0.8
1000 kg		1000	800	2000	1400	1000	1400	1000	1120	800
2000 kg		2000	1600	4000	2800	2000	2800	2000	2240	1600
3000 kg		3000	2400	6000	4200	3000	4200	3000	3360	2400
4000 kg		4000	3200	8000	5600	4000	5600	4000	4480	3200
5000 kg		5000	4000	10000	7000	5000	7000	5000	5600	4000
6000 kg		6000	4800	12000	8400	6000	8400	6000	6720	4800
8000 kg		8000	6400	16000	11200	8000	11200	8000	8960	6400
10000 kg		10000	8000	20000	14000	10000	14000	10000	11200	8000

Round slings Rated capacities for different slinging methods

Factor		WLL (kg) with one round sling					WLL (kg) with two round slings					
		straight pull	choke hitch	basket angle β			straight angle β		choke hitch angle β			
				up to 7°	7°-45°	45°-60°	7°-45°	45°-60°	7°-45°	45°-60°		
		1.0	0.8	2.0	1.4	1.0	0.7	0.5	1.4	1.0	1.12	0.8
1000 kg		1000	800	2000	1400	1000	700	500	1400	1000	1120	800
2000 kg		2000	1600	4000	2800	2000	1400	1000	2800	2000	2240	1600
3000 kg		3000	2400	6000	4200	3000	2100	1500	4200	3000	3360	2400
4000 kg		4000	3200	8000	5600	4000	2800	2000	5600	4000	4480	3200
5000 kg		5000	4000	10000	7000	5000	3500	2500	7000	5000	5600	4000
6000 kg		6000	4800	12000	8400	6000	4200	3000	8400	6000	6720	4800
8000 kg		8000	6400	16000	11200	8000	5600	4000	11200	8000	8960	6400
10000 kg		10000	8000	20000	14000	10000	7000	5000	14000	10000	11200	8000



Round sling with duplex sleeve model RSD

Made from polyester (PES), EN 1492-2 with double stitch-less protection sleeve, with capacity label.

Features

- With double protection sleeve, PU-starched, thermally fixed.
- Colour coding of the protective sleeve.
- Printed-on capacities.
- Woven tonnage stripes, per ton capacity 1 stripe (applies only to round slings up to 10t).
- Low weight allows easy handling.
- Protection against hand injuries.
- Protection against cargo surface damage.
- Highly flexible and adaptable to given shapes.
- UV-resistant, eliminating material ageing or embrittlement.
- Heat resistant up to +100 °C.
- Moisture-resistant fabric, thus preventing frost damage (up to approx. -40 °C).



INFO

Further capacities and special lengths available on request.

Technical data model RSD

Model	Colour code EN 1492	Capacity WLL, with one sling, straight pull kg	Capacity WLL, with one sling, basket, angle β up to 7° kg	Capacity WLL, with one sling, basket, angle β 7°- 45° kg	Capacity WLL, with one sling, basket, angle β 45°- 60° kg	Capacity WLL, with one sling, choke hitch kg	Width approx. under load mm	Thickness approx. under load mm	Shortest possible length for special makes mm
RSD-01000	violet	1000	2000	1400	1000	800	52	5	500
RSD-02000	green	2000	4000	2800	2000	1600	57	6	500
RSD-03000	yellow	3000	6000	4200	3000	2400	71	9	500
RSD-04000	grey	4000	8000	5600	4000	3200	76	9	1000

**XL-Round sling
model RSX**

Made from polyester (PES), EN 1492-2 with extra strong stitchless protection sleeve, with capacity label.

Features

- Optimized woven structure, PU-starched, thermally fixed.
- Easy identification of the annually required UVV tests through an additional label showing a check list.
- Colour coding of the protective sleeve.
- Printed-on capacities.
- Woven tonnage stripes, per ton capacity 1 stripe (applies only to round slings up to 10t).
- Low weight allows easy handling.
- Protection against hand injuries.
- Protection against cargo surface damage.
- Highly flexible and adaptable to given shapes.
- UV-resistant, eliminating material ageing or embrittlement.
- Heat resistant up to +100 °C.
- Moisture-resistant fabric, thus preventing frost damage (up to approx. -40 °C).



INFO

Further capacities (up to 100t) and special lengths available on request.

Technical data model RSX

Model	Colour code EN 1492	Capacity WLL, with one sling, straight pull kg	Capacity WLL, with one sling, basket, angle β up to 7° kg	Capacity WLL, with one sling, basket, angle β 7°- 45° kg	Capacity WLL, with one sling, basket, angle β 45°- 60° kg	Capacity WLL, with one sling, choke hitch kg	Width approx. under load mm	Thickness approx. under load mm	Shortest possible length for special makes mm
RSX-01000	violet	1000	2000	1400	1000	800	52	10	500
RSX-02000	green	2000	4000	2800	2000	1600	57	10	500
RSX-03000	yellow	3000	6000	4200	3000	2400	71	15	500
RSX-04000	grey	4000	8000	5600	4000	3200	76	15	1000
RSX-05000	red	5000	10000	7000	5000	4000	86	20	1000
RSX-06000	brown	6000	12000	8400	6000	4800	96	20	2000
RSX-08000	blue	8000	16000	11200	8000	6400	112	25	2000
RSX-10000	orange	10000	20000	14000	10000	8000	130	30	2000



Round sling with single sleeve model RSE

Made from polyester (PES), EN 1492-2 with stitchless protection sleeve, with capacity label.

Features

- With single sleeve, PU-starched, thermally fixed.
- Colour coding of the protective sleeve.
- Printed-on capacities.
- Woven tonnage stripes, per ton capacity 1 stripe (applies only to round slings up to 10t).
- Low weight allows easy handling.
- Protection against hand injuries.
- Protection against cargo surface damage.
- Highly flexible and adaptable to given shapes.
- UV-resistant, eliminating material ageing or embrittlement.
- Heat resistant up to +100 °C.
- Moisture-resistant fabric, thus preventing frost damage (up to approx. -40 °C).

INFO

Special lengths available on request.

Technical data model RSE

Model	Colour code EN 1492	Capacity WLL, with one sling, straight pull kg	Capacity WLL, with one sling, basket, angle β up to 7° kg	Capacity WLL, with one sling, basket, angle β 7°- 45° kg	Capacity WLL, with one sling, basket, angle β 45°- 60° kg	Capacity WLL, with one sling, choke hitch kg	Width approx. under load mm	Thickness approx. under load mm	Shortest possible length for special makes mm
RSE-01000	violet	1000	2000	1400	1000	800	50	10	500
RSE-02000	green	2000	4000	2800	2000	1600	55	10	500
RSE-03000	yellow	3000	6000	4200	3000	2400	60	15	500
RSE-04000	grey	4000	8000	5600	4000	3200	75	15	1000
RSE-05000	red	5000	10000	7000	5000	4000	85	20	1000
RSE-06000	brown	6000	12000	8400	6000	4800	90	20	2000
RSE-08000	blue	8000	16000	11200	8000	6400	100	25	2000
RSE-10000	orange	10000	20000	14000	10000	8000	120	30	2000

20 RSE - Round slings,
EN 1492-2

with different working loads and lengths.

With each sport bag you receive:

- 2 x RSE 01000, WLL 1000 kg, 0.5 m length
- 4 x RSE 01000, WLL 1000 kg, 1.0 m length
- 2 x RSE 01000, WLL 1000 kg, 1.5 m length
- 4 x RSE 01000, WLL 1000 kg, 2.0 m length
- 2 x RSE 02000, WLL 2000 kg, 1.0 m length
- 2 x RSE 02000, WLL 2000 kg, 2.0 m length
- 2 x RSE 02000, WLL 2000 kg, 3.0 m length
- 2 x RSE 03000, WLL 3000 kg, 2.0 m length



EAN-No.: 4025092360555
Minimum purchase: 3 bags



Including sports bag

Round sling assembly Rated capacities for different slinging methods

	single legged		double legged				three and four legged	
	straight pull	choke hitch	straight pull angle β 0°-45°	choke hitch	straight pull angle β 45°-60°	choke hitch	straight pull angle β 0°-45° 45°-60°	
Factor	1.0	0.8	1.4	1.1	1.0	0.8	2.1	1.5
1000 kg	1000	800	1400	1100	1000	800	2100	1500
2000 kg	2000	1600	2800	2200	2000	1600	4200	3000
3000 kg	3000	2400	4200	3300	3000	2400	6300	4500
5000 kg	5000	4000	7000	5500	5000	4000	10500	7500
8000 kg	8000	6400	11200	8800	8000	6400	16800	12000



**Round sling assembly
single legged
model RSG**

EN 1492-2 with high tensile forgings EN 1677.

Technical data model RSG single legged

Model	Capacity WLL straight pull kg
RSG-01000-1-SIKA	1000
RSG-02000-1-SIKA	2000
RSG-03000-1-SIKA	3000
RSG-05000-1-SIKA	5000
RSG-08000-1-SIKA	8000



**Round sling assembly
double legged
model RSG**

EN 1492-2 with high tensile forgings EN 1677.

Technical data model RSG double legged

Model	Capacity WLL, straight pull angle β 0°-45° kg	Capacity WLL, straight pull angle β 45°-60° kg
RSG-01000-2-SIKA	1400	1000
RSG-02000-2-SIKA	2800	2000
RSG-03000-2-SIKA	4200	3000
RSG-05000-2-SIKA	7000	5000
RSG-08000-2-SIKA	11200	8000

**Round sling assembly
three legged
model RSG**

EN 1492-2 with high tensile forgings EN 1677.

Technical data model RSG three legged

Model	Capacity WLL, straight pull angle β 0°-45° kg	Capacity WLL, straight pull angle β 45°-60° kg
RSG-01000-3-SIKA	2100	1500
RSG-02000-3-SIKA	4200	3000
RSG-03000-3-SIKA	6300	4500
RSG-05000-3-SIKA	10500	7500
RSG-08000-3-SIKA	16800	12000



**Round sling assembly
four legged
model RSG**

EN 1492-2 with high tensile forgings EN 1677.

Technical data model RSG four legged

Model	Capacity WLL, straight pull angle β 0°-45° kg	Capacity WLL, straight pull angle β 45°-60° kg
RSG-01000-4-SIKA	2100	1500
RSG-02000-4-SIKA	4200	3000
RSG-03000-4-SIKA	6300	4500
RSG-05000-4-SIKA	10500	7500
RSG-08000-4-SIKA	16800	12000



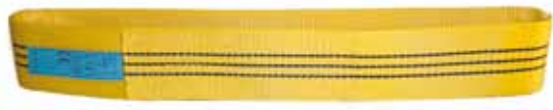

Endless flat webbing sling, single ply model HSE

Made from polyester (PES), EN 1492-1 form A2, with capacity label.

- Heat resistant up to +100 °C.
- Moisture-resistant fabric, thus preventing frost damage (up to approx. -40 °C).
- Low elongation (<4%).

Features

- Single ply, PU-starched, thermally fixed.
- Colour coded webbing (only model HSE).
- Woven tonnage stripes (only model HSE).
- Low weight allows easy handling.
- Protection against hand injuries.
- Protection against cargo surface damage.
- Consistent pressure distribution onto pressure- and pull sensitive loads.
- UV-resistant, eliminating material ageing or embrittlement.



INFO

Further capacities (up to 20 t) and special lengths available on request.

Technical data model HSE

Model	Colour code EN 1492	Capacity WLL, with one sling, straight pull kg	Capacity WLL, with one sling, basket, angle β up to 7° kg	Capacity WLL, with one sling, basket, angle β 7°- 45° kg	Capacity WLL, with one sling, basket, angle β 45°- 60° kg	Capacity WLL, with one sling, choke hitch kg	Webbing width mm	Shortest possible length for special makes mm
HSE-01000	violet	1000	2000	1400	1000	800	30	500
HSE-02000	green	2000	4000	2800	2000	1600	60	500
HSE-03000	yellow	3000	6000	4200	3000	2400	90	500
HSE-04000	grey	4000	8000	5600	4000	3200	120	1000

Endless flat webbing sling, single ply, one-way model HSE-E

Made from polyester (PES), DIN 60005, with capacity label.



Technical data model HSE-E one-way-sling

Model	Capacity WLL, with one sling, straight pull kg	Capacity WLL, with one sling, basket, angle β up to 7° kg	Capacity WLL, with one sling, basket, angle β 7°- 45° kg	Capacity WLL, with one sling, basket, angle β 45°- 60° kg	Capacity WLL, with one sling, choke hitch kg	Webbing width mm	Shortest possible length for special makes mm
HSE-E-00500 one-way-sling	500	1000	700	500	400	25	200
HSE-E-00750 one-way-sling	750	1500	1050	750	600	48	200
HSE-E-01000 one-way-sling	1000	2000	1400	1000	800	35	200
HSE-E-01500 one-way-sling	1500	3000	2100	1500	1200	50	250

**Flat webbing sling,
duplex construction,
reinforced eyes
model HBD**

Made from polyester (PES), EN 1492-1 form B2, with capacity label.

Features

- Duplex construction, PU-starched, thermally fixed.
- With reinforced eyes.
- Woven tonnage stripes.
- Low weight allows easy handling.
- Protection against hand injuries.
- Protection against cargo surface damage.
- Consistent pressure distribution onto pressure- and pull sensitive loads.
- UV-resistant, eliminating material ageing or embrittlement.
- Heat resistant up to +100 °C.
- Moisture-resistant fabric, thus preventing frost damage (up to approx. -40 °C).
- Low elongation (< 4%).



INFO

Special lengths available on request.

Technical data model HBD

Model	Colour code EN 1492	Capacity WLL, with one sling, straight pull kg	Capacity WLL, with one sling, basket, angle β up to 7° kg	Capacity WLL, with one sling, basket, angle β 7°- 45° kg	Capacity WLL, with one sling, basket, angle β 45°- 60° kg	Capacity WLL, with one sling, choke hitch kg	Webbing width mm	Eye length approx. mm	Eye width approx. mm	Shortest possible length for special makes mm
HBD-01000	violet	1000	2000	1400	1000	800	30	300	15	750
HBD-02000	green	2000	4000	2800	2000	1600	60	350	30	1000
HBD-03000	yellow	3000	6000	4200	3000	2400	90	400	45	1000
HBD-04000	grey	4000	8000	5600	4000	3200	120	500	60	1500
HBD-05000	red	5000	10000	7000	5000	4000	150	550	75	1500
HBD-06000	brown	6000	12000	8400	6000	4800	180	600	90	2000
HBD-08000	blue	8000	16000	11200	8000	6400	240	650	120	2500
HBD-10000	orange	10000	20000	14000	10000	8000	300	900	150	2500



Flat webbing sling, four ply, reinforced eyes model HBQ

Made from polyester (PES), EN 1492-1 form B4, with capacity label.

Colour coding up to 16000 kg not according to EN 1492-1.



Features

- Four-layered stitched, PU-starched, thermally fixed.
- With reinforced eyes.
- Low weight allows easy handling.
- Protection against hand injuries.
- Protection against cargo surface damage.
- Consistent pressure distribution onto pressure- and pull sensitive loads.
- UV-resistant, eliminating material ageing or embrittlement.
- Heat resistant up to +100 °C.
- Moisture-resistant fabric, thus preventing frost damage (up to approx. -40 °C).
- Low elongation (< 4%).

Technical data model HBQ

Model	Capacity WLL, with one sling, straight pull kg	Capacity WLL, with one sling, basket, angle β up to 7° kg	Capacity WLL, with one sling, basket, angle β 7°- 45° kg	Capacity WLL, with one sling, basket, angle β 45°- 60° kg	Capacity WLL, with one sling, choke hitch kg	Webbing width mm	Eye length approx. mm	Eye width approx. mm	Shortest possible length for special makes mm
HBQ-04000	4000	8000	5600	4000	3200	60	350	30	1000
HBQ-06000	6000	12000	8400	6000	4800	90	400	45	1000
HBQ-08000	8000	16000	11200	8000	6400	120	500	60	1500
HBQ-10000	10000	20000	14000	10000	8000	150	550	75	1500
HBQ-12000	12000	24000	16800	12000	9600	180	600	90	2000
HBQ-16000	16000	32000	22400	16000	12800	240	650	120	2500
HBQ-20000	20000	40000	28000	20000	16000	300	900	150	2500
HBQ-25000	25000	50000	35000	25000	20000	300	900	150	2500

Webbing sling,
duplex construction,
steel links on both ends
model HBD-SN and
model HBD-SD

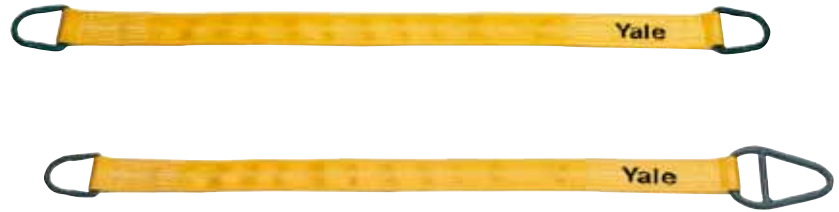

Made from polyester (PES), EN 1492-1 form C2 and Cr2, with capacity label.

Features

- Duplex construction, PU-starched, thermally fixed.
- With steel D- and DP-links (reevable).
- Woven tonnage stripes.
- Low weight allows easy handling.
- Protection against hand injuries.
- Protection against cargo surface damage.
- Consistent pressure distribution onto pressure- and pull sensitive loads.
- UV-resistant, eliminating material ageing or embrittlement.
- Heat resistant up to +100 °C.
- Moisture-resistant fabric, thus preventing frost damage (up to approx. -40 °C).
- Low elongation (< 4%).

INFO

Model HBD-SD - links are reevable, webbing sling also applicable for use in choke hitch.

Technical data model HBD-SN and model HBD-SD

Model	Colour code EN 1492	Capacity WLL, with one sling, straight pull kg	Capacity WLL, with one sling, basket, angle β up to 7° kg	Capacity WLL, with one sling, basket, angle β 7° - 45° kg	Capacity WLL, with one sling, basket, angle β 45° - 60° kg	Capacity WLL, with one sling, choke hitch kg	Webbing width mm	Link dimension HBD-SN bxdxt mm 	Link dimension HBD-SD bxdxt mm 
HBD-01000	violet	1000	2000	1400	1000	800	30	35x13x100	30x13x145
HBD-02000	green	2000	4000	2800	2000	1600	60	75x16x130	60x16x165
HBD-03000	yellow	3000	6000	4200	3000	2400	90	105x18x140	90x18x190
HBD-04000	grey	4000	8000	5600	4000	3200	120	130x22x130	120x22x240
HBD-05000	red	5000	10000	7000	5000	4000	150	170x26x170	150x26x300
HBD-06000	brown	6000	12000	8400	6000	4800	180	190x26x220	180x26x320
HBD-08000	blue	8000	16000	11200	8000	6400	240	250x26x230	240x26x360
HBD-10000	orange	10000	20000	14000	10000	8000	300	300x40x290	300x40x435

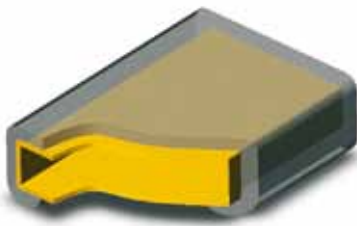

PU-protection sleeve single-sided,
model PU-SC-1

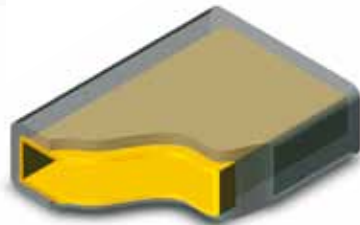

PU-protection sleeve double-sided,
model PU-SC-2

PU-protection sleeve, single and double-sided model PU-SC

Made from cut resistant polyurethane

With inner fabric insert to ease sliding of the sleeve on the webbing. Standard length 2 and 4 m.

Double PU sleeves cannot be fitted subsequently on webbing slings with steel links. If required, state sleeve length when placing the webbing sling order.

Technical data model PU-SC, single-sided

Model	EAN-No. 4025092*	Webbing width	Dimensions outside / inside	Height
		mm	mm	mm
PU-SC1-030	*357906	30	50 / 40	22
PU-SC1-050	*352680	50	70 / 60	22
PU-SC1-060	*352697	60	80 / 70	22
PU-SC1-090	*352710	90	110 / 100	22
PU-SC1-120	*357951	120	145 / 135	22
PU-SC1-150	*357876	150	170 / 160	22
PU-SC1-180	*357869	180	200 / 190	22
PU-SC1-240	*357883	240	260 / 250	31
PU-SC1-300	*357890	300	330 / 320	31

Technical data model PU-SC, double-sided

Model	EAN-No. 4025092*	Webbing width	Dimensions outside / inside	Height
		mm	mm	mm
PU-SC2-030	*357944	30	50 / 40	22
PU-SC2-050	*352741	50	70 / 60	22
PU-SC2-060	*352758	60	80 / 70	22
PU-SC2-090	*352772	90	110 / 100	22
PU-SC2-120	*352802	120	145 / 135	22
PU-SC2-150	*352826	150	170 / 160	22
PU-SC2-180	*357913	180	200 / 190	22
PU-SC2-240	*357920	240	260 / 250	31
PU-SC2-300	*357937	300	330 / 320	31

INFO

Lengths over 4 m on request.

PU-edge protector model PU-KSW

Made from cut resistant polyurethane
With slots to allow easy attachment and fixing on the round sling.



Technical data model PU-KSW

Model	EAN-No. 4025092*	Diameter mm	Length mm	Suitable for round slings up to WLL kg
PU-KSW-30	*357067	30	80	3000
PU-KSW-50	*357074	50	125	5000

Round sleeve model PU-SG

With fabric insert and PU-coating
Economical solution to protect webbing slings and round slings against wear caused by abrasion.



INFO

Not suitable for protection against sharp edges.

Technical data model PU-SG

Model	EAN-No. 4025092*	Width approx. mm	Length mm	Diameter mm	Suitable for round slings up to WLL kg
PU-SG-040	*352840	60	1000	40	2000
PU-SG-063	*352857	95	1000	63	3000
PU-SG-075	*352864	115	1000	75	6000
PU-SG-090	*352871	140	1000	90	8000
PU-SG-110	*352888	170	1000	110	10000
PU-SG-150	*352895	230	1000	150	15000

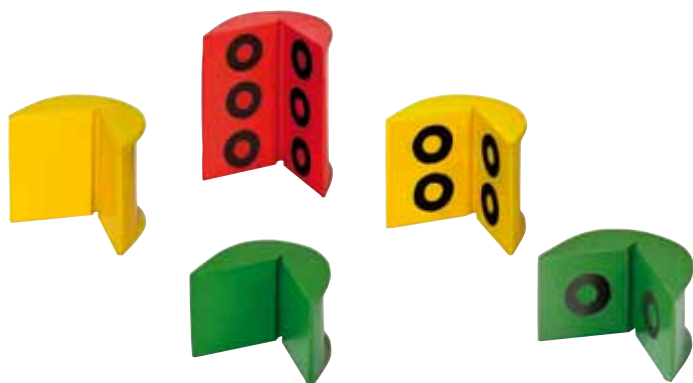

Edge protection profile, with and without magnets model PU-KSE

From colour coded polyurethane, extremely abrasive and cut resistant.

Technical data model PU-KSE

Model	EAN-No. 4025092*	Colour mm	Webbing width mm	Number of magnets
PU-KSE-065	*912303	green	60	–
PU-KSE-100	*912310	yellow	90	–
PU-KSE-125	*912327	grey	120	–
PU-KSE-150	*912389	red	150	–
PU-KSE-200	*912396	black	180	–
PU-KSE-300	*912402	orange	300	–

Technical data model PU-KSE-MAG

Model	EAN-No. 4025092*	Colour mm	Webbing width mm	Number of magnets
PU-KSE-065-MAG	*912419	green	60	2
PU-KSE-100-MAG	*912426	yellow	90	4
PU-KSE-125-MAG	*912433	grey	120	4
PU-KSE-150-MAG	*912440	red	150	4
PU-KSE-200-MAG	*912457	black	180	6
PU-KSE-300-MAG	*912464	orange	300	8

PU-coating, single and double-sided model PU-FB

Made from transparent polyurethane

Extremely wear and cut resistant. The coating is permanently fixed to the webbing and cannot be lost during usage.

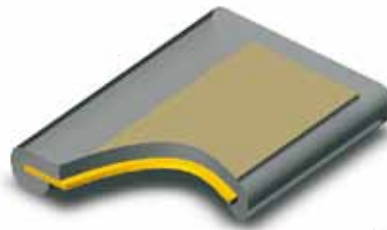

Coating single-sided,
model PU-FB 1

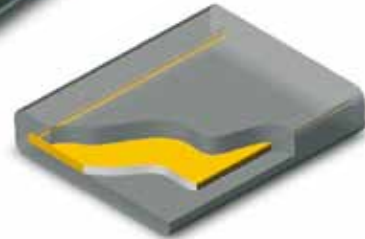

Coating double-sided,
model PU-FB 2

Technical data model PU-FB, single-sided

Model	EAN-No. 4025092*	Webbing width mm	Width mm	Length mm
PU-FB1-030	*358620	30	40	1000
PU-FB1-050	*352529	50	60	1000
PU-FB1-060	*352536	60	70	1000
PU-FB1-090	*352543	90	100	1000
PU-FB1-120	*352550	120	130	1000
PU-FB1-150	*352567	150	160	1000
PU-FB1-180	*352574	180	190	1000
PU-FB1-240	*352581	240	250	1000
PU-FB1-300	*352598	300	310	1000

Technical data model PU-FB, double-sided

Model	EAN-No. 4025092*	Webbing width mm	Width mm	Length mm
PU-FB2-030	*358637	30	40	1000
PU-FB2-050	*352604	50	60	1000
PU-FB2-060	*352611	60	70	1000
PU-FB2-090	*352628	90	100	1000
PU-FB2-120	*352635	120	130	1000
PU-FB2-150	*352642	150	160	1000
PU-FB2-180	*352659	180	190	1000
PU-FB2-240	*352666	240	250	1000
PU-FB2-300	*352673	300	310	1000

OFNE

General information about load security

The varying forces, which can result in slipping, rolling, tilting or even lift-off of loads during transport, are regularly underestimated. Possible consequences are e.g. that the vehicle gets out of control, the driving cab is damaged, the vehicle even overturns and the falling load endangers others! The common assumption that very heavy loads do not require lashing security, is a fatal error. Lashing of loads may be performed by competent users (trained in theory and practice) only.

Some basic rules about load security with ratchet lashings

- Depending on the cargo, consideration shall be given to select an appropriate vehicle with adequate structures and lashing points.
- The load centre of gravity should be as low as possible and ideally positioned according to the load distribution plan of the vehicle.
- The permissible gross weight and loads per axle must not be exceeded.
- The load should be stored as close and low as possible and should not leave free space between load, front wall or side walls. Free spaces between the outer walls and the load should be stuffed where possible.
- Depending on the type of cargo, the driving speed should be conform to the road and traffic situation as well as to the driving quality of the vehicle.
- Adverse friction values between cargo and loading area (oily metals, wet areas etc.) will considerably increase the requirement for a correct security of the load. Slip restraining mats will contribute to achieve a more economic and efficient load lashing security.
- Unstable cargo is very susceptible to tilting and in most cases has to be lashed extensively (calculation against slipping and tilting).
- Positive load lashing (e.g. supporting the cargo at front and side walls or with wedges or scantlings fixed on the loading platform) will contribute substantially to the stabilisation of the cargo and to reduction of additional lashing requirement.

Forces on cargo loads (EN 12195)

Truck and trailer loading (road transport) – Acceleration coefficients

During road transport the heaviest stresses on the load security equipment will occur during braking, lift-off of the load by vibration and impact as well as centrifugal forces in narrow curves.

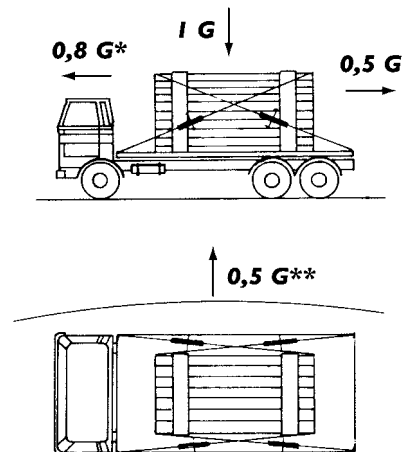

* The value for the longitudinal acceleration in combined traffic (lorry and/or trailer during rail transport) has to be calculated with 1G.

** 0.7 for tilting of instable cargo loads

Lashing methods

Over top lashing

Over top lashing consists of tensioning the lashings to the tension force so as to increase the friction force at the contact surface of the load to avoid any sliding of the load. Influence factors are the dimensions of the load, the acceleration values, the dynamic friction factors as well as the lashing angle.

The calculation of lashing forces will give the required tension force of the lashing devices.

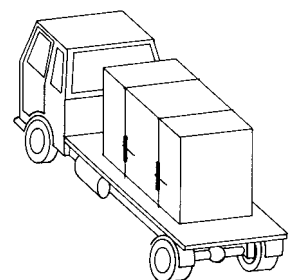

This user information presents a general overview regarding the application of web lashings and does not substitute the existing operating instructions for specific products!

Lashing operations with textile lashing equipment may be carried out by competent users (trained in theory and practice) only. When operated correctly, our textile lashings offer the highest degree of safety in line with long life expectancy and avoid damage to material and people.

Limitations of use

Temperature

Textile lashings in accordance with this part of the European standard EN 12195 are suitable for the following temperature areas:

- a) -40 °C up to +80 °C for polypropylene (PP)
- b) -40 °C up to +100 °C for polyamide (PA)
- c) -40 °C up to +120 °C for polyester (PES)

These temperature areas may change in chemical environments. In this case consult the manufacturer or supplier for advice.

A change of the ambient temperature during transport may influence the tension force of the textile lashing. The tension force should be checked after entering warm regions.

Chemicals

The resistance against chemical influences varies depending on the materials used for the textile lashing. Please observe the advice of the manufacturer, if the textile lashings are subjected to chemicals. Also consider that the effect of the chemical influence will increase with rising temperatures. The resistance of synthetic fibre against chemical influences is summarised as follows:

- a) Polyamides are resistant against alkaline but affected by mineral acids.
- b) Polyester is resistant against mineral acids but affected by alkaline solutions.
- c) Polypropylene is hardly affected by acids and alkaline and is suited for applications that require high resistance against chemicals (except some organic solvents).
- d) Harmless acid or alkaline solutions may be concentrated by evaporation and lead to damages. Affected textile lashings have to be taken out of service immediately, thoroughly rinsed in cold water and dried in the open-air.

Operation in danger zones

During loading and unloading observe low hanging aerial contact lines.

Application advices

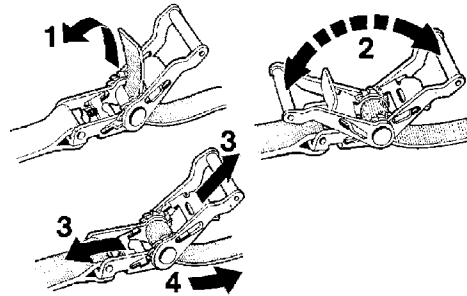

- Selection and use of textile lashings depend on the required tensioning force as well as the mode of application and type of cargo to be lashed. Size, form and weight of the cargo determine the correct choice in addition to the intended usage. For stability reasons, at least two lashing systems should be used for over top lashing and two pairs of lashing straps for diagonal lashing.
- The selected web lashing must be strong enough for the intended job and have the correct length for the type of lashing. Always consider adequate lashing practice: Attachment and removal of lashings should be planned before the start of the journey. In case of longer trips, partial unloadings must be considered. The number of lashings must be calculated as per EN 12195-1:2000. Over top lashing requires systems, which are labelled STF for over top lashing.
- On account of different characteristics and change of length under load, different lashings (e.g. lashing chains and web lashings) may not be used for lashing the same load. When using additional fittings or lashing devices, make sure that these correspond to the existing web lashing.
- During operation, flat hooks must be in contact with the full width of the hook mouth.

O
L
E
N

INFO

- Releasing of the lashing: Prior to releasing, make sure that the load stands safely (even without safety device) and does not endanger the operator by falling. Before departure check whether additional lashings will be required for further transportation after partial unloading has occurred.
This is also true for lashing elements which permit safe removal.
- Prior to unloading, the lashings must be released to an extent that the load stands freely.
- Make sure that the web lashing will not be damaged by the edges of the cargo. A visual inspection should be standard procedure before and after each usage.
- Only use textile lashings with legible identity labels.
- Textile lashings must not be overloaded:
The max. hand force of 500 N (50 daN on the label; 1 daN = approx. 1 kg) may be applied with one hand only. Do not use cheater bars or levers unless they are part of the lashing element.
- Knotted textile lashings must not be used.
- Damages to the identity labels should be avoided by keeping them away from the edges of the cargo.
- Textile lashings should be protected against friction and abrasion and damages by sharp edges by application of protective sleeves and/or edge protectors.

Labelling

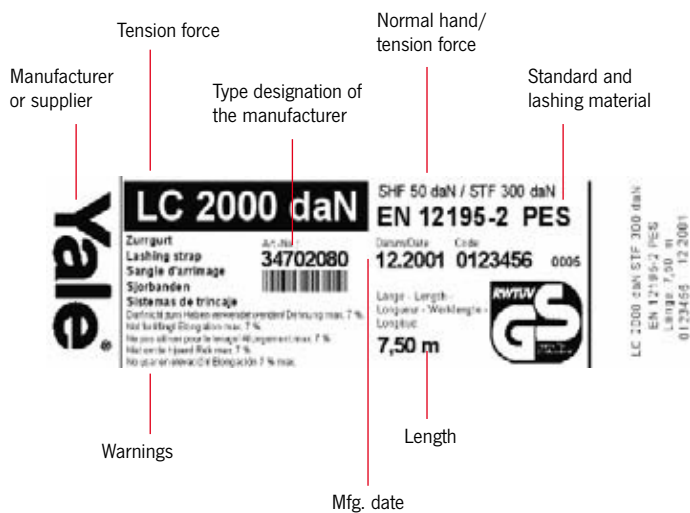

Maintenance and repair

Textile lashings may only be repaired if provided with legible identity labels. In case of accidental contact with chemicals, the web lashing has to be withdrawn from service and the manufacturer or supplier consulted for advice.

Criteria for disposal of textile lashings

Textile lashings must be withdrawn from service and returned for repair to the manufacturer in case of obvious defects. The following points are signs of possible damages:

Textile lashings:

- Cracks, cuts, notches and breaks in the load bearing strands and seams as well as deformations by heat;

Tensioning devices and fittings:

- Deformations, cracks, obvious signs of wear and corrosion.

The quantity of textile lashings has to be calculated according to EN 12195-1:2010

Only use lashing systems for over top lashing which show STF on the label. For easy identification of the required quantity of textile lashings or existing lashings needed for the cargo to be lashed refer to the following table, which has been calculated with friction coefficients of $\mu = 0.2$, $\mu = 0.4$ and $\mu = 0.6$ at various angles of elevation α .

- The calculation refers to situations with min. two, however max. ten textile lashings.
- Whenever possible, always use a slip resistant mat with a certified friction coefficient of 0.6!
- Always operate with the highest possible angle of elevation and lash as steep as possible!!!
- The friction coefficients are applicable for clean and dry surfaces, well covered from frost, ice and snow. In case of moisture refer to the direct lashing method or double the amount of textile lashings!

Friction factors according to EN 12195-1:2010

Combination of materials in the contact surface	Friction factor μ	when using a slip resistant mat
Cut timber against fabric base laminate/plywood	0.5	0.6
Cut timber against grooved aluminium	0.4	0.6
Cut timber against steel sheets	0.4	0.6
Cut timber against shrink films	0.3	0.6
Shrink films against fabric base laminate/plywood	0.4	0.6
Shrink films against grooved aluminium	0.4	0.6
Shrink films against steel sheets	0.4	0.6
Shrink films against shrink films	0.4	0.6
Cardboard box against cardboard box	0.5	0.6
Cardboard box against wooden pallet	0.5	0.6
Big bags against wooden pallet	0.4	0.6
Flat steel bars against cut timber	0.5	0.6
Unpainted corrugated sheets against cut timber	0.5	0.6
Painted corrugated sheets against cut timber	0.4	0.6
Unpainted corrugated sheets against unpainted corrugated sheets	0.3	0.6
Painted corrugated sheets against painted corrugated sheets	0.2	0.6

Number of required textile lashings for different cargo weights

- at different friction factors
- at different angles

Tension force of ratchet 300 daN at standard hand force of 50 daN according to EN 12195

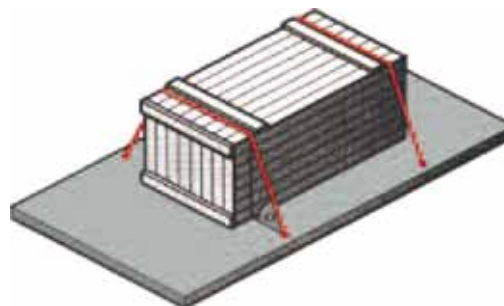

Applicable to textile lashings ZGR-50-2500 with LC 2500 daN and ZGR-50-2000 with LC 2000 daN

Cargo weight	Friction factor μ 0.20 Top angle			Friction factor μ 0.40 Top angle			Friction factor μ 0.60 Top angle		
	30°	60°	90°	30°	60°	90°	30°	60°	90°
1000 kg		10	9	7	4	3	3	2	2
2000 kg					8	7	6	3	3
3000 kg						10	9	5	4
4000 kg								7	6
5000 kg								8	7
6000 kg								10	9
7000 kg									10
8000 kg									
9000 kg									
10000 kg									

Cells without indication require more than 10 web lashings. In these cases a reasonable cargo securing can only be obtained by direct lashing method. Obstruction forces by cargo boards and form-fit locking devices have not been considered.



Cambuckle lashing model ZGK-25-125

Made from polyester (PES), EN 12195-2
25 mm - lashing capacity LC 125 daN.

Features

- Standard tension force STF 30 daN at standard hand force SHF 50 daN.
- Standard lengths 4 m and 6 m.

INFO

Other lengths on request.

Technical data model ZGK-25-125

Model	EAN-No. 4025092*	Version	Permissible ratchet force LC daN	Webbing width mm	Webbing length mm
ZGK-25-125-1	*352505	1 piece	125	25	4000
ZGK-25-125-1	*352512	1 piece	125	25	6000



Ratchet lashing model ZGR-25-250

Made from polyester (PES), EN 12195-2
25 mm - lashing capacity LC 250 daN.

Features

- Standard tension force STF 50 daN at standard hand force SHF 50 daN.
- Standard lengths 4 m and 6 m.



INFO

Other lengths on request.

Technical data model ZGR-25-250

Model	EAN-No. 4025092*	Version	Permissible ratchet force LC daN	Webbing width mm	Webbing length mm
ZGR-25-250-1	*352017	1 piece	250	25	4000
ZGR-25-250-1	*352024	1 piece	250	25	6000
ZGR-25-250-2-SPH	*352383	2 part - with claw hook	250	25	4000
ZGR-25-250-2-SPH	*352390	2 part - with claw hook	250	25	6000

Ratchet lashing model ZGR-25-500

Made from polyester (PES), EN 12195-2
25 mm - lashing capacity LC 500 daN.

Features

- Standard tension force STF 100 daN at standard hand force SHF 50 daN.
- Standard lengths 4 m and 6 m.



INFO

Other lengths on request.

Technical data model ZGR-25-500

Model	EAN-No. 4025092*	Version	Permissible ratchet force LC daN	Webbing width mm	Webbing length mm
ZGR-25-500-1	*352031	1 piece	500	25	4000
ZGR-25-500-1	*352048	1 piece	500	25	6000
ZGR-25-500-2-SPH	*352406	2 part - with claw hook	500	25	4000
ZGR-25-500-2-SPH	*352413	2 part - with claw hook	500	25	6000



**Ratchet lashing
model ZGR-35-1000**

Made from polyester (PES), EN 12195-2
35 mm - lashing capacity LC 1000 daN.

Features

- Standard tension force STF 150 daN at standard hand force SHF 50 daN.
- Standard lengths 6 m and 8 m.



GKH - with twisted snap hook



SPH - with claw hook

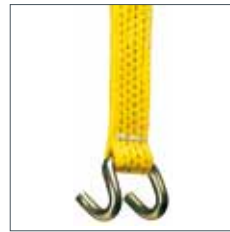

KLH - with chassis hook



Technical data model ZGR-35-1000

Model	EAN-No. 4025092*	Version	Permissible ratchet force LC daN	Webbing width mm	Webbing length mm
ZGR-35-1000-1	*352055	1 piece	1000	35	6000
ZGR-35-1000-1	*352062	1 piece	1000	35	8000
ZGR-35-1000-2-GKH	*352147	2 part - with snap hook	1000	35	6000
ZGR-35-1000-2-GKH	*352154	2 part - with snap hook	1000	35	8000
ZGR-35-1000-2-KLH	*352208	2 part - with chassis hook	1000	35	6000
ZGR-35-1000-2-KLH	*352215	2 part - with chassis hook	1000	35	8000
ZGR-35-1000-2-SPH	*352420	2 part - with claw hook	1000	35	6000
ZGR-35-1000-2-SPH	*352437	2 part - with claw hook	1000	35	8000

INFO

Other end fittings (hooks) and individual prints on webbing are available on request.

Other lengths on request.

Ratchet lashing model ZGR-50-2000

Made from polyester (PES), EN 12195-2
50 mm - lashing capacity LC 2000 daN.

Features

- Standard tension force STF 300 daN at standard hand force SHF 50 daN.
- Standard lengths 8m and 10m.



GKH - with twisted snap hook



SPH - with claw hook

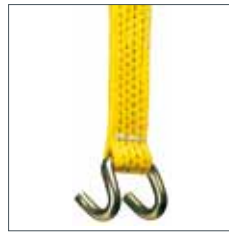

KLH - with chassis hook

Technical data model ZGR-50-2000

Model	EAN-No. 4025092*	Version	Permissible ratchet force LC daN	Webbing width mm	Webbing length mm
ZGR-50-2000-1	*352086	1 piece	2000	50	8000
ZGR-50-2000-1	*352079	1 piece	2000	50	10000
ZGR-50-2000-2-GKH	*352178	2 part - with snap hook	2000	50	8000
ZGR-50-2000-2-GKH	*352161	2 part - with snap hook	2000	50	10000
ZGR-50-2000-2-KLH	*352239	2 part - with chassis hook	2000	50	8000
ZGR-50-2000-2-KLH	*352222	2 part - with chassis hook	2000	50	10000
ZGR-50-2000-FE-KLH	*356640	Fixed end with ratchet	2000	50	400
ZGR-50-2000-2-SPH	*352451	2 part - with claw hook	2000	50	8000
ZGR-50-2000-2-SPH	*352444	2 part - with claw hook	2000	50	10000
ZGR-50-2000-FE-SPH	*356657	Fixed end with ratchet	2000	50	400

INFO

Other end fittings (hooks) and individual prints on webbing are available on request.

Other lengths on request.



Ratchet lashing model ZGR-50-2500

Made from polyester (PES), EN 12195-2
50 mm - lashing capacity LC 2500 daN.

Features

- Standard tension force STF 300 daN at standard hand force SHF 50 daN.
- Standard lengths 8m and 10m



GKH - with twisted snap hook



SPH - with claw hook

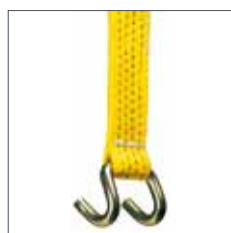

KLH - with chassis hook

Technical data model ZGR-50-2500

Model	EAN-No. 4025092*	Version	Permissible ratchet force LC daN	Webbing width mm	Webbing length mm
ZGR-50-2500-1	*352109	1 piece	2500	50	8000
ZGR-50-2500-1	*352093	1 piece	2500	50	10000
ZGR-50-2500-2-GKH	*352192	2 part - with snap hook	2500	50	8000
ZGR-50-2500-2-GKH	*352185	2 part - with snap hook	2500	50	10000
ZGR-50-2500-2-KLH	*352253	2 part - with chassis hook	2500	50	8000
ZGR-50-2500-2-KLH	*352246	2 part - with chassis hook	2500	50	10000
ZGR-50-2500-FE-KLH	*356664	Fixed end with ratchet	2500	50	400
ZGR-50-2500-2-SPH	*352475	2 part - with claw hook	2500	50	8000
ZGR-50-2500-2-SPH	*352468	2 part - with claw hook	2500	50	10000
ZGR-50-2500-FE-SPH	*356671	Fixed end with ratchet	2500	50	400

INFO

Other end fittings (hooks) and individual prints on webbing are available on request.

Other lengths on request.

Ratchet lashing model ZGR-75-5000

Made from polyester (PES), EN 12195-2
75 mm - lashing capacity LC 5000 daN.

Features

- Standard tension force STF 500 daN at standard hand force SHF 50 daN.
- Standard lengths 2 m and 4 m.



SPH - with claw hook

Technical data model ZGR-75-5000

Model	EAN-No. 4025092*	Version	Permissible ratchet force LC daN	Webbing width mm	Webbing length mm
ZGR-75-5000-1	*352116	1 piece	5000	75	2000
ZGR-75-5000-1	*352123	1 piece	5000	75	4000
ZGR-75-5000-2-SPH	*352482	2 part - with claw hook	5000	75	2000
ZGR-75-5000-2-SPH	*352499	2 part - with claw hook	5000	75	4000

INFO

Other end fittings (hooks) and individual prints on webbing are available on request.

Other lengths on request.



Ratchet lashing with long lever ratchet model ZGR-XL-50-2000 or model ZGR-XLZ-50-2000

Made from polyester (PES), EN 12195-2
50 mm - lashing capacity LC 2000 daN.

Features

- Standard tension force STF 500 daN at standard hand force SHF 50 daN.
- Long lever ratchet with precise interlocking.
- Long lever push ratchet model ZGR-XL with device for controlled release.
- Long lever pull ratchet model ZGR-XLZ, ergonomic design.
- Standard lengths 8 m and 10 m.

INFO

Other end fittings (hooks) and individual prints on webbing are available on request.

Other lengths on request.



Long lever ratchet
with precise interlocking. Device for controlled release.



GKH - with twisted snap hook



SPH - with claw hook

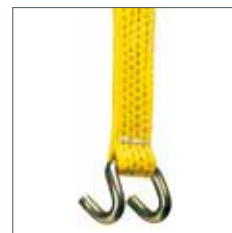

KLH - with chassis hook

Technical data model ZGR-XL-50-2000 with device for controlled release

Model	EAN-No. 4025092*	Version	Permissible ratchet force LC daN	Webbing width mm	Webbing length mm
ZGR-XL-50-2000-1	*360579	1 piece	2000	50	8000
ZGR-XL-50-2000-1	*360562	1 piece	2000	50	10000
ZGR-XL-50-2000-2-GKH	*360593	2 part - with snap hook	2000	50	8000
ZGR-XL-50-2000-2-GKH	*360586	2 part - with snap hook	2000	50	10000
ZGR-XL-50-2000-2-KLH	*360616	2 part - with chassis hook	2000	50	8000
ZGR-XL-50-2000-2-KLH	*360609	2 part - with chassis hook	2000	50	10000
ZGR-XL-50-2000-2-SPH	*360630	2 part - with claw hook	2000	50	8000
ZGR-XL-50-2000-2-SPH	*360623	2 part - with claw hook	2000	50	10000

Technical data model ZGR-XLZ-50-2000 ergonomic design

Model	EAN-No. 4025092*	Version	Permissible ratchet force LC daN	Webbing width mm	Webbing length mm
ZGR-XLZ-50-2000-1	*646260	1 piece	2000	50	8000
ZGR-XLZ-50-2000-1	*646284	1 piece	2000	50	10000
ZGR-XLZ-50-2000-2-GKH	*646352	2 part - with snap hook	2000	50	8000
ZGR-XLZ-50-2000-2-GKH	*646369	2 part - with snap hook	2000	50	10000
ZGR-XLZ-50-2000-2-KLH	*646390	2 part - with chassis hook	2000	50	8000
ZGR-XLZ-50-2000-2-KLH	*646406	2 part - with chassis hook	2000	50	10000
ZGR-XLZ-50-2000-2-SPH	*475549	2 part - with claw hook	2000	50	8000
ZGR-XLZ-50-2000-2-SPH	*475556	2 part - with claw hook	2000	50	10000

Ratchet lashing with long lever ratchet model ZGR-XL-50-2500 or model ZGR-XLZ-50-2500

Made from polyester (PES), EN 12195-2
50 mm - lashing capacity LC 2500 daN.



Features

- Standard tension force STF 500 daN at standard hand force SHF 50 daN.
- Long lever ratchet with precise interlocking.
- Long lever push ratchet model ZGR-XL with device for controlled release.
- Long lever pull ratchet model ZGR-XLZ, ergonomic design.
- Standard lengths 8 m and 10 m.

INFO

Other end fittings (hooks) and individual prints on webbing are available on request.

Other lengths on request.



Long lever ratchet with precise interlocking. Device for controlled release.



GKH - with twisted snap hook



SPH - with claw hook

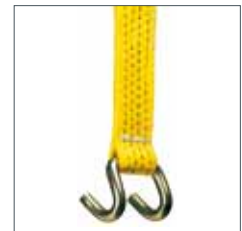

KLH - with chassis hook

Technical data model ZGR-XL-50-2500 with device for controlled release

Model	EAN-No. 4025092*	Version	Permissible ratchet force LC daN	Webbing width mm	Webbing length mm
ZGR-XL-50-2500-1	*360654	1 piece	2500	50	8000
ZGR-XL-50-2500-1	*360647	1 piece	2500	50	10000
ZGR-XL-50-2500-2-GKH	*360678	2 part - with snap hook	2500	50	8000
ZGR-XL-50-2500-2-GKH	*360661	2 part - with snap hook	2500	50	10000
ZGR-XL-50-2500-2-KLH	*360692	2 part - with chassis hook	2500	50	8000
ZGR-XL-50-2500-2-KLH	*360685	2 part - with chassis hook	2500	50	10000
ZGR-XL-50-2500-2-SPH	*360715	2 part - with claw hook	2500	50	8000
ZGR-XL-50-2500-2-SPH	*360708	2 part - with claw hook	2500	50	10000

Technical data model ZGR-XL-50-2500 ergonomic design

Model	EAN-No. 4025092*	Version	Permissible ratchet force LC daN	Webbing width mm	Webbing length mm
ZGR-XLZ-50-2500-1	*646291	1 piece	2500	50	8000
ZGR-XLZ-50-2500-1	*646321	1 piece	2500	50	10000
ZGR-XLZ-50-2500-2-GKH	*646376	2 part - with snap hook	2500	50	8000
ZGR-XLZ-50-2500-2-GKH	*646383	2 part - with snap hook	2500	50	10000
ZGR-XLZ-50-2500-2-KLH	*646413	2 part - with chassis hook	2500	50	8000
ZGR-XLZ-50-2500-2-KLH	*646420	2 part - with chassis hook	2500	50	10000
ZGR-XLZ-50-2500-2-SPH	*475563	2 part - with claw hook	2500	50	8000
ZGR-XLZ-50-2500-2-SPH	*475570	2 part - with claw hook	2500	50	10000



Truck lashing model ZGR-SLE

Made from polyester, EN 12195-2

With rail anchor suitable for fixing rails.

Technical data model ZGR-SLE

Model	EAN-No. 4025092*	Version	Permissible ratchet force LC daN	Webbing width mm	Length fixed end LGF mm	Length loose end LGL mm
ZGR-50-1000-2-SLE	*356527	2 part	1000	50	500	3500

INFO

Other lengths on request.



Container lashing model ZGR-CZR

Made from polyester, EN 12195-2

Container lashing with ratchet and round sling with reinforced loop and protection hose.

Only suitable for empty containers.

Technical data model ZGR-CZR

Model	EAN-No. 4025092*	Version	Permissible ratchet force LC daN	Webbing width mm	Round sling 3000 kg, useable length mm	Length fixed end LGF mm	Length loose end LGL mm
ZGR-50-2500-2-CZR	*356534	2 part	2500	50	1250	400	600



Ratchet base model ZGZB-RU

Manufactured from cut resistant polyurethane.

Can also be used as edge protector.

Technical data model ZGZB-RU

Model	EAN-No. 4025092*	For webbing width mm
ZGZB-RU-PU-50	*352901	35 - 50
ZGZB-RU-PU-75	*352918	75

Automatic ratchet lashing model ZGA

Made from polyester, EN 12195-2

Features

- With automatic ratchet.
- Quick and precise fixing of load.
- Stepless adjustment.
- Easy rolling of webbing strap.
- PVC coated S-Hook to protect the loading space.



Technical data model ZGR-DSPH

Model	EAN-No. 4053981**	Version	Permissible ratchet force LC daN	Webbing width mm	Webbing length mm
ZGA-25-300	**022536	2 part - with S-hook	300	25	3000
ZGA-50-750	**022543	2 part - with claw hook	750	50	3000

Car-Lashing (wheel-lashing) model ZGR-CL

Made from polyester, EN 12195-2

Scope of delivery

- Ratchet with integrated swivel hook
- Belt with single J-hook
- Single J-hook loosely attached to belt
- Protective tyre sleeve
(one side coated with special rubber), length 0.75 m



Technical data model ZGR-CL

Model	EAN-No. 4025092*	Version	Permissible ratchet force LC daN	Webbing width mm	Webbing length mm
ZGR-35-1500-1-EWR	*928373	1 piece	1500	35	2500
ZGR-35-1500-2-E-E-E	*928359	2 part	1500	35	2500
ZGR-50-2500-1-EWR	*928380	1 piece	2500	50	2500
ZGR-50-2500-2-E-E-E	*928366	2 part	2500	50	2500

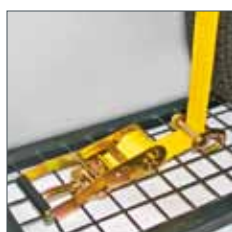

Ratchet with swivel hook



Single J-hook



Protective tyre sleeve



Edge protector model ZGZB-KS

Edge protector for lashing sensitive loads (cardboard boxes etc.).

Technical data model ZGZB-KS

Model	EAN-No. 4025092*	For webbing width mm
ZGZB-KS-PP-50	*352949	50



Edge protector model ZGZB-KS-60

Inherently stable edge protection, protects both load and ratchet lashing.

Leg lengths 135x170 mm.

Technical data model ZGZB-KS

Model	EAN-No. 4053981**	For webbing width mm
ZGZB-KS-PP-60	**022598	up to 70



Edge protector profile model ZGZB-KSP

Manufactured from polypropylene or recycled cardboard, to protect edges of loads. Length up to 6 m.

Technical data model ZGZB-KSP

Model	EAN-No. 4025092*	Dimensions mm
ZGZB-KSP-PP	*356688	190 x 190 x 20

Slip restraining mats model ZGZB-ARM

Even if an emergency stop or evasive action is being taken – the cargo trucks or train wagons must not move. But only in very few cases the vehicle structure alone will offer sufficient load security.

For this reason, slip restraining devices should belong to the standard equipment of every professional transport. Slip restraining mats will decrease the danger which emanates from plain loading platforms. They will reduce the required total pre-tensioning forces during over top lashing of loads and will contribute – together with the textile lashings – that the loads will form a single unit with the vehicle or wagon.

The slip restraining effect will benefit especially those products, which do not stand a high surface pressure. The dangers resulting from incorrect load lashing practices are often underestimated. Acceleration forces in standard driving situations are close to the dead weight of the load.

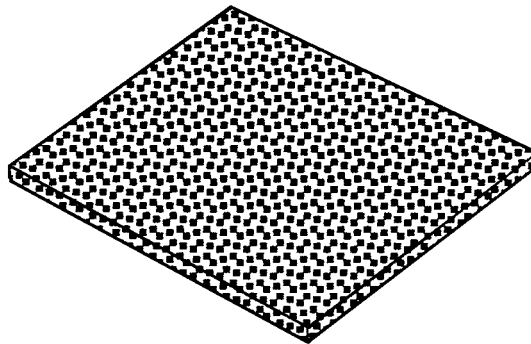

Technical data model ZGZB-ARM

Model	EAN-No. 4025092*	Dimensions mm
ZGZB-ARM-250-8	*352963	1000x250x8

The friction force FW of a slip restraining mat impedes load displacement and is physically explained as follows:

$$FW = m \times G$$

G = Weight force

m = Friction value

The difference between inertial force F and friction force FW is called securing force FS.

$$FS = F - FW$$

The securing force FS is the strength which has to be absorbed by the safety devices.

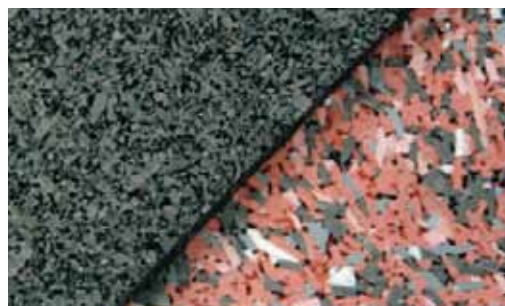



Load binders model RLSP

Lashing capacity 4000 - 10600 daN

The load binder is a universal tool to restrain and secure loads and freight. Manual operation of the binder lever extends or retracts the threaded spindles. Tension is upheld by the self-locking threads.

The load binder is fitted with shortening hooks for direct attachment to chains or with clevis ends for use with existing fastening devices.

Technical data model RLSP

Model	EAN-No. 4025092*	Version	Lashing capacity LC daN	Weight kg
RLSP-08-ÖÖ	*457880	Clevis	4000	3.6
RLSP-10-ÖÖ	*457897	Clevis	6300	3.6
RLSP-13-ÖÖ	*457903	Clevis	10600	3.8
RLSP-08-HH	*457859	Shortening hooks	4000	4.5
RLSP-10-HH	*457866	Shortening hooks	6300	5.5
RLSP-13-HH	*457873	Shortening hooks	10600	8.4

Dimensions model RLSP

Model	RLSP-08-ÖÖ	RLSP-10-ÖÖ	RLSP-13-ÖÖ	RLSP-08-HH	RLSP-10-HH	RLSP-13-HH
Chain size, mm	8	10	13	8	10	13
B1, mm	250	250	250	250	250	250
B2 min., mm	360	360	366	588	630	722
B2 max., mm	510	510	516	738	780	872
Ø E, mm	20	20	25	-	-	-
L, mm	230	230	360	190	230	360

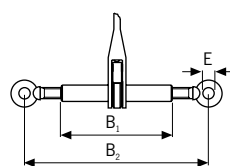

Load binder with protection against unscrewing, clevis acc. to EN 12195-3 on both ends.

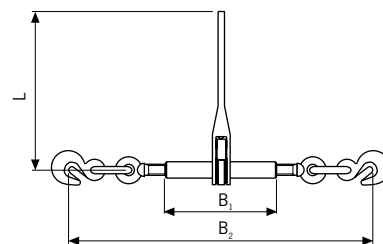

Load binder with protection against unscrewing, clevis or shortening hook acc. to EN 12195-3 on both ends.

Weld-on hooks model ASH

Capacity 1000 - 8000 kg

Weld-on hooks model ASH are universal attachments for use on trucks, excavators, low loaders and spreader beams, etc. The forged safety latch has high lateral stability and an ergonomic shape. Every weld-on hook has an identification number so that its history can be traced back through forging to the origin of the material.

The hook can be welded without any special preparation, e.g. prewarming.

The hook and safety latch are epoxy resin coated for added corrosion protection, the return spring is made from stainless steel.



Technical data model ASH

Model	EAN-No. 4025092*	Capacity kg	Weight kg
ASH 1	*453073	1000	0.5
ASH 3	*453011	3000	1.3
ASH 5	*453028	5000	2.4
ASH 8	*453035	8000	3.6

Dimensions model ASH

Model	ASH 1	ASH 3	ASH 5	ASH 8
Seam density, a	4	6	7	8 - 9
L1 x B1, mm	90 x 25	130 x 35	160 x 45	170 x 50
B2, mm	19	26	30	40
C, mm	24	32	40	51
H1, mm	6	10	12	12
H2, mm	76	117	121	142
L2, mm	22	29	47	52

